

Getting Started

With Your EO™ Personal Communicator



Getting Started

With Your EO™ Personal Communicator



© 1992, 1993 EO, Inc. All rights reserved.

EO, the EO logo, EO Personal Communicator, EO Lock, EO Phone, EO Sound, EO Calc, and EO Cellular Module are trademarks of EO, Inc.

A number of trademarks and registered trademarks appear in this manual. The companies listed below own the marks following their names:

AT&T: AT&T Mail, EasyLink, AT&T EasyLink Services;
GO Corporation: GO Fax, GO Mail, PenPoint, MiniText,
MiniNote; Pensoft Corporation: Personal Perspective; Sun
Microsystems: PenCentral, PenTOPS; Notable Corporation:
PenCross.

Terms and conditions for AT&T Easylink Services are subject to change without notice.

EO Publications

This manual was written by Ann Cullen, under the direction of Ted Barnett, Product Manager. The book was designed by frogdesign.

Printed on recycled paper.

Welcome

Welcome to the world of EO™ personal communications. The ten easy sessions in this guide are designed to bring you quickly up to speed on your new EO Personal Communicator 440 or EO Personal Communicator 880.

A Quick Orientation

Your EO Personal Communicator (referred to in this guide as your EO) combines advanced communications technology with a familiar pen-and-paper way of working. You can use your EO to send and receive faxes and electronic mail over standard telephone lines, or you can communicate wirelessly, using the optional EO Cellular Module™.

Your EO hardware can connect you with the world

Your EO Personal Communicator is loaded with connectivity hardware, including standard PC (serial) and printer (parallel) ports, a keyboard port, a phone port for a standard phone line, and a communications port for the optional EO Cellular Module. The EO 880 also has a SCSI port and a VGA port to which you can connect an external monitor.

Everything you need is already here

All the tools you need for personal and business communications come ready to use. Your EO Personal Communicator is lightweight, battery-powered, and mobile.

Your EO is an integrated solution

Your EO Personal Communicator offers a unique combination of hardware and software that gives you the edge in communications. But your EO is more than a communications tool. It's also a powerful computer you can use to capture, analyze, and transmit information, write and revise documents,

and manage personal, business, and financial information. Built-in software includes the following:

- **GO Mail** An application you use to send, receive, and work with electronic mail (e-mail).
- **GO Fax** An application you use to send, receive, and work with faxes.
- **EO Phone™** An application you use to dial the phone and place voice calls.
- **Personal Perspective** An appointments calendar, address book, and information manager you use to manage time and monitor to-do items.
- **EO Sound™** An application that allows you to add voice notes—sound recordings—to documents.
- **MiniText** A simple word-processing application you use to enter and format text.
- **MiniNote** An application you use to create simple graphics and handwritten notes in electronic ink.
- **EO Calc™** A miniature “columnar pad” you use to work with numbers.
- **EO Lock™** An accessory that provides password protection for the EO to keep your data secure.
- **PenTOPS and PenCentral** Applications you use to connect your EO to a PC so that you can access information on any IBM-compatible PC.

What You Can Do

You'll find your EO Personal Communicator a versatile device that will become your everyday companion. Here are a few ways it can enhance your daily routine and help you stay in touch.

Productivity

- Use the EO Phone application to dial voice calls directly from the Personal Perspective Address Book or Day Planner.
- Jot down budget revisions in an EO Calc page and fax the numbers directly to the office.
- Write a memo in a MiniText document and send it by e-mail to multiple team members listed in your Address Book.
- Keep track of tasks to be done, appointments, and upcoming events in the Personal Perspective Day Planner.
- Move a word-processing document created on your desktop PC into your EO. You can edit and update the document with the EO pen and fax the document to several colleagues.

Creativity

- Sketch a plan for a new product in electronic ink in a MiniNote document.
- Add an EO Sound voice note to a memo and send it by e-mail to other owners of EO Personal Communicators. Recipients can play back your note and hear your comments, complete with the vocal emphasis you add.

Mobility

- Write memos or notes and fax them from your car, using the optional EO Cellular Module.
- Address and send an e-mail note in the middle of a meeting, using the EO Cellular Module or by plugging into a standard phone line in the meeting room.

- Fax a request for data and receive the data directly on the EO, without leaving your hotel room.
- Put the lightweight EO Personal Communicator in your lap on long airline trips and jot notes, draw sketches, or work on financial plans.

Before You Start

Your EO Personal Communicator is easy to use, but to use it successfully you need to learn a new way of using a pen. The gestures you use on the EO represent a new “alphabet.” Printing and writing by hand on the screen represent a new way of adding information. Most people need a little time to become accustomed to these new skills, so don’t worry if you make a few mistakes, or if the EO doesn’t seem to “understand” you.

Practice is essential

Whether you’re new to computers or an advanced user, we encourage you to spend an hour or two with this guide. By working through the ten startup sessions, you’ll save much time and trouble later on, when you put your EO to work.

You may need to train your handwriting

You use the special EO pen to write and make gestures on the screen, as described in this guide. Most EO users get gestures and handwriting right only after they’ve put in some practice. You may need to adapt your style of printing for better recognition by your EO. If you become frustrated at first, remember that you’re learning a completely new technology. Practice should make you an expert user in just a few hours.

If you’re an experienced mouse user

Even if you’re an experienced mouse user, EO recommends that you work through *Getting Started*. Although tapping with the

pen is similar to clicking a mouse button, many conventions are different. Keep the following in mind:

- Avoid the temptation to double tap. You need to tap only once to select an item.
- Use the Contents tab to return to the Table of Contents. Don't close the Notebook. It's a book, not a window.

If You Don't Read Manuals

If you don't read manuals, you may want to work through sessions 2 through 4 of this guide. These sessions show you how to open on-screen tutorials that introduce the EO Notebook and other software.

***Important information about the battery** Don't skip section 1, "Setting Up the EO." This session provides important information about setting up the EO, starting it, and restoring the charge to the main battery.*

If you're a light reader, you're probably also an experimenter. A context-sensitive help system is available as you try things out. To open help, write a question mark anywhere on the screen. Tap the Help Notebook button to turn to the EO's built-in reference manual.

Contents

	Welcome	iii
	A Quick Orientation	iii
	What You Can Do	v
	Before You Start	vi
	If You Don't Read Manuals	vii
1	Setting Up the EO	1
	Before You Begin	1
	Connecting the Power Adapter	2
	Understanding Power States	4
	Installing the Backup Batteries	5
	Installing the Main Battery	6
	Setting Up for Communications	8
	Switching the EO On	10
	Troubleshooting	12
	Taking Out the Pen	12
2	Introducing the Notebook	13
	Notebook Basics	13
	Starting the Tutorial	15
	Finishing the EO Tutorial	17
	Getting On-Screen Help	17
	Turning to Help	18
	Closing Help	19
3	Handwriting Practice	21
	Aligning the Pen	21
	Opening Handwriting Practice	23
	Finishing Handwriting Practice	24
4	Gesture Practice	25
	Starting Gesture Practice	25
	Finishing Gesture Practice	27

5	Setting the Day and Time	29
	Setting Today's Date	29
	Setting the Time	30
	Opening the Clock	32
6	Faxing a Note	33
	Creating a Note	33
	Renaming the Note	34
	Writing the Note	36
	Correcting Other Mistakes	38
	Preparing the Note for Faxing	38
	Adding the Recipient's Fax Number	40
	Transmitting the Fax	41
	More About MiniNote and GO Fax	44
7	Writing a Letter	45
	About Text	45
	Creating a New MiniText Document	46
	Adding More Text	50
	Inserting a Word in the Middle	50
	Returning to the Table of Contents	51
	More About MiniText	51
8	Organizing Your Day	53
	Turning to the Day Planner	53
	Switching to Text	54
	Scheduling an Appointment	55
	Moving the Appointment	56
	Moving the Appointment to a Different Day	56
	Canceling an Appointment	57
	Turning to the Address Book	57
	Using Intelligent Text	59
	Writing a Linked Note	61
	Checking the Note	61
	More About Personal Perspective	62

9	Recharging the Battery	63
	Recharging	63
	Disconnecting the Adapter Cable	64
	On Your Own	65
	Where to Go from Here	66
10	Registration	69
	Registering Your EO	69
	Registering for AT&T Mail	70
	EO Customer Service	71
	Appendix: Software License	73

Setting Up the EO

This session shows you how to set up your EO™ Personal Communicator 440 or EO Personal Communicator 880. First-time setup should take from 5 to 10 minutes.

As you set up your EO, follow the sequence of topics and the numbered steps carefully. The sequence is designed to ensure that your batteries are properly installed and charged.

If you purchased an optional EO Cellular Module™, don't connect it until you've set up the EO. "Setting Up for Communications," on page 8 in this guide, shows the appropriate point for connecting the Cellular Module.

Before You Begin

Before you begin the setup process, take a moment to check the contents of the Accessory Kit.

- 1. Remove the EO Personal Communicator from the antistatic bag and place it on a clean, flat surface.**
- 2. Check the contents of the Accessory Kit to see that you have everything you need.**

In addition to this *Getting Started* guide, the Accessory Kit should contain the following items:

- Book: *Lookup Guide to the EO Personal Communicator*.
- Book: *The World of Messaging: An Introduction to Personal Communications*.
- Slipcase for the EO.
- Main battery.
- Two type CR123A batteries (the backup batteries).

- AC power adapter with attached DC cable and power cable.
- EO Utilities floppy disk.
- EO phone line and duplex jack.
- PC connection (serial) cable and adapter.

Connecting the Power Adapter

The main battery of your EO is partially discharged during shipment. Before you can install the main battery, the EO must be connected to the power adapter, switched on, and then switched to Standby state. The adapter supplies power so that the EO can set itself up properly before you install the main battery.

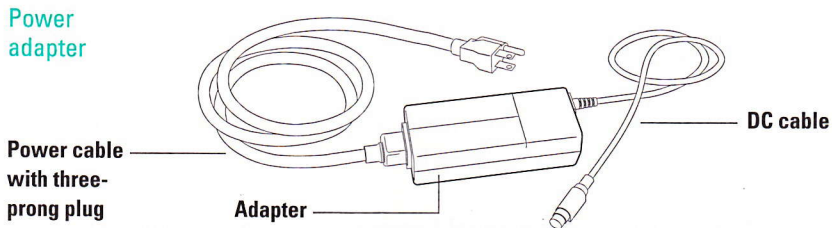

- 1. Take the power adapter and its power cable out of the Accessory Kit.**
The power cable has a standard three-prong plug on one end.
- 2. Plug one end of the power cable into the adapter and the other end into a power outlet.**
Make sure that you connect the power cable to a grounded power outlet.
- 3. Plug the adapter's DC cable into the power adapter port on the EO (a port is the same thing as a socket).**
The flat side of the connector should point toward the bottom of the EO.

Connecting to the power adapter port

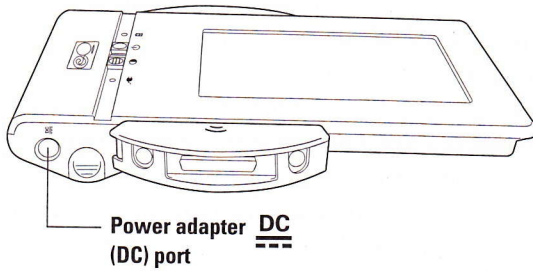

The green charging light comes on to show that the power adapter is connected, and the EO immediately begins its startup process.

4. Wait about 3 minutes as the EO starts up.

During startup, a picture of a pen appears on the screen. The pen fills with ink as startup proceeds. Don't worry if the bar in the pen stops for 30 seconds or so—this is normal.

If you don't see anything Try adjusting the contrast control slider.

Brightness and contrast sliders

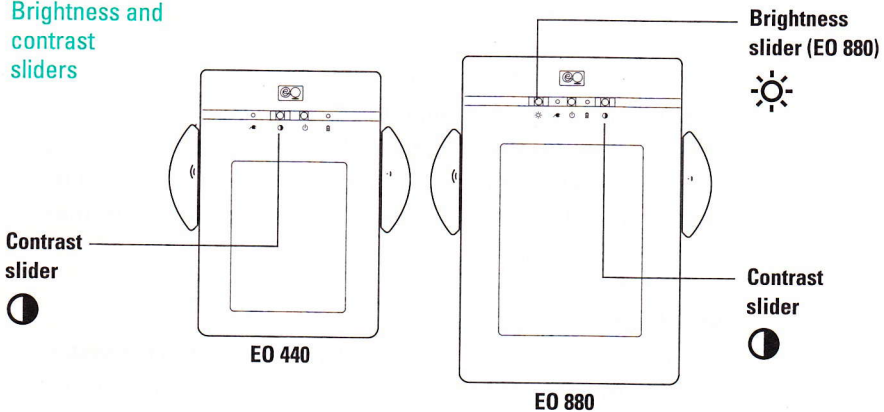

While the EO is starting up, take a moment to review some important information about how the EO manages power by reading “Understanding Power States,” next.

5. When the Notebook appears on the screen, the startup procedure is complete.

Before you begin to use the EO, you need to put it in Standby state and install the batteries.

Understanding Power States

The EO has three power states: On, Standby, and Shutdown. For complete information on power states, refer to section 1 of the *Lookup Guide to the EO Personal Communicator* after you’ve finished this guide.

On

The main battery or power adapter supplies full power to the system, and the Notebook is visible. The main battery does not recharge in the On state, even with the power adapter connected.

Standby

Standby is a sort of “cat-nap” power state. A trickle of power from the main battery is supplied to the system so that all documents and software in the EO working space (RAM) are maintained. When you switch from Standby to On, the EO is ready to use. To save power, the EO automatically drops into Standby after 5 minutes if there’s no activity.

Shutdown

The EO is completely off. No power is supplied to the system, except a trace from the coin cell battery, which maintains the EO clock. Unless you have a hard disk for storage, all documents in the EO memory are erased at Shutdown. You should need to put your EO in Shutdown only when you add a DRAM card or change the ROM card.

Importance of Backups

In the On and Standby states, the information you add to the EO is stored in memory. When you switch to Shutdown state, memory is cleared and all information is lost (except that on a hard disk or other storage device). *If you don't have a hard disk, never switch to Shutdown until you've backed up the information in your EO.* For instructions on backing up, refer to the *Lookup Guide to the EO Personal Communicator*, section 12, "Backups and Copies."

Installing the Backup Batteries

A set of two backup batteries supplies power to the EO when the main battery runs down or while it is being replaced.

1. **Leave the AC adapter plugged in, and press the On/Standby button to switch the EO to Standby.**

Warning *Never remove or install batteries when the EO is on. You could lose information by changing batteries while the power is on.*

On/Standby
button

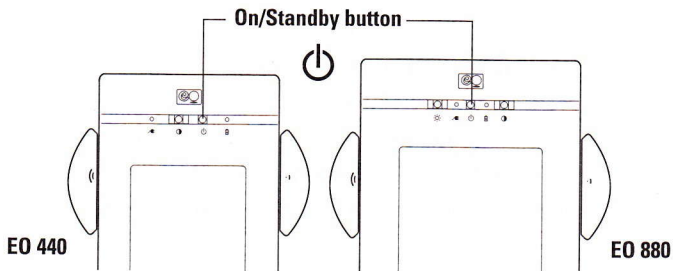

2. **Gently slide out the backup battery compartment door (shown in the next picture).**

Opening the compartment

Backup battery door (slides down)

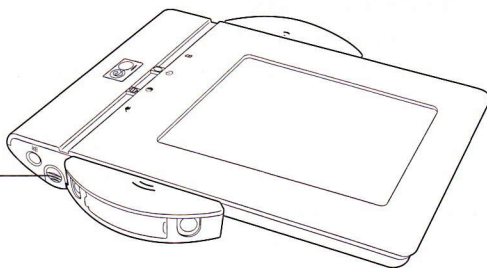

3. Insert the two backup batteries, with the positive (+) ends pointing outward from the compartment.

Installing the backup batteries

Backup batteries

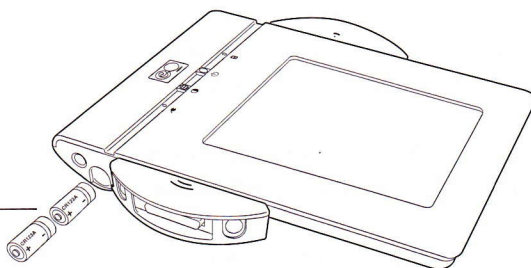

4. Replace the backup battery compartment door.

Installing the Main Battery

The rechargeable main battery is the principal source of power to the EO. Since the main battery has been partially discharged during shipment, you'll need to recharge it. Recharging is covered later in this guide.

1. With the EO still in Standby, remove the main battery compartment door.

Opening the
battery door

Main battery
latch

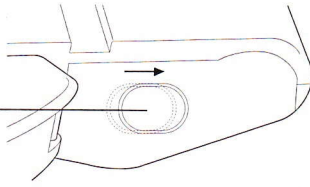

Slide the latch to
unlock the
battery door.

Pull the door
down to remove it.

2. Insert the main battery.

Inserting the
main battery

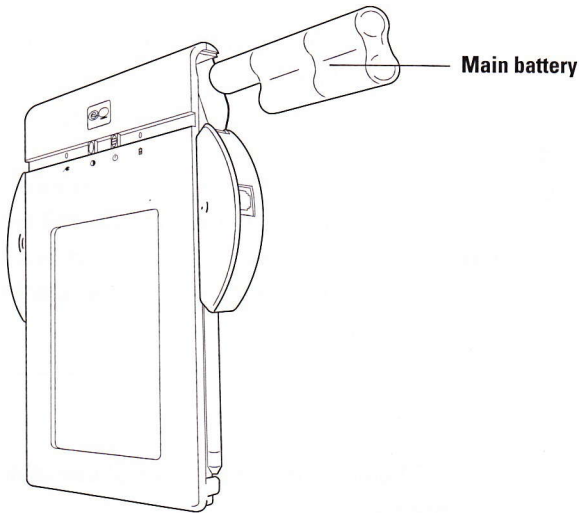

3. Replace the compartment door.

**4. Leave the EO in Standby while you set up for communications
in the next topic.**

Setting Up for Communications

To use your EO Personal Communicator for fax, e-mail, and phone calls, you need to connect the EO to a phone line.

If your EO is a 4MB system, or if you don't have a modem With a 4-megabyte system, fax and e-mail applications are not available for use. If you don't have a modem in your EO, you won't be able to communicate over a phone line.

EO Cellular Module

If you have an optional EO Cellular Module, you should connect it to the EO now. For instructions, refer to *Connecting with Your EO Cellular Module*, and return to this guide when the Cellular Module is attached.

Standard Phone Line

1. Take the EO phone cord and duplex phone jack out of the Accessory Kit.

The EO phone cord has a small “bump” near one end of the cord. This bump contains electronics that help reduce electrical emissions during telephone transmissions. Whenever you connect your EO to a phone jack, you should use the EO phone cord provided and make sure that the end nearest the bump is plugged into the EO.

2. Unplug the existing phone cord from its wall outlet and plug the duplex jack into the wall outlet.

Using the duplex jack allows you to keep both the EO and a standard phone connected to the wall outlet.

Duplex jack

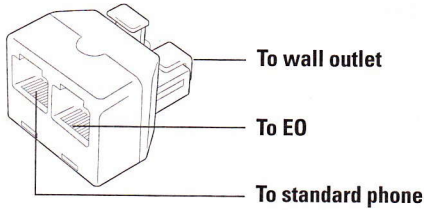

3. Insert the existing phone cord into one side of the duplex jack (either side will work).
4. Insert the non-bump end of the EO phone cord into the other side of the duplex jack.
5. Insert the bump end of the EO phone cord into the phone port of the EO.

The phone port is on the right side of the EO as you face the screen. A telephone icon identifies the port.

Attaching the phone line

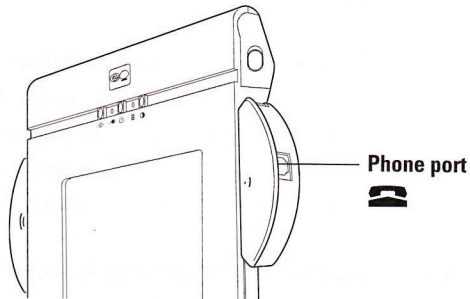

Your EO Personal Communicator is now completely set up and ready to switch on.

Switching the EO On

Since the startup procedure was completed earlier, the screen and Notebook will come to life almost immediately when you switch to the On state.

1. Press the On/Standby button.

Switching the EO on

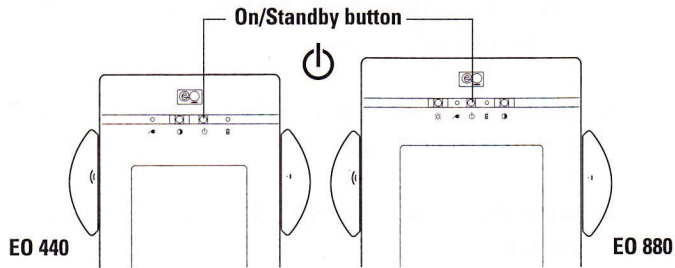

The Notebook appears in a moment, and you're ready to continue with this guide.

***Recharging still to come** The main battery has not yet been recharged, so the EO should remain connected to the power adapter for the time being. At the end of this guide, you'll learn how to fully charge the battery.*

2. Adjust screen contrast and brightness to a comfortable level by moving the sliders to the right or left.

On the EO 440, you can adjust screen contrast. On the EO 880, you can adjust both contrast and brightness.

Brightness and contrast sliders

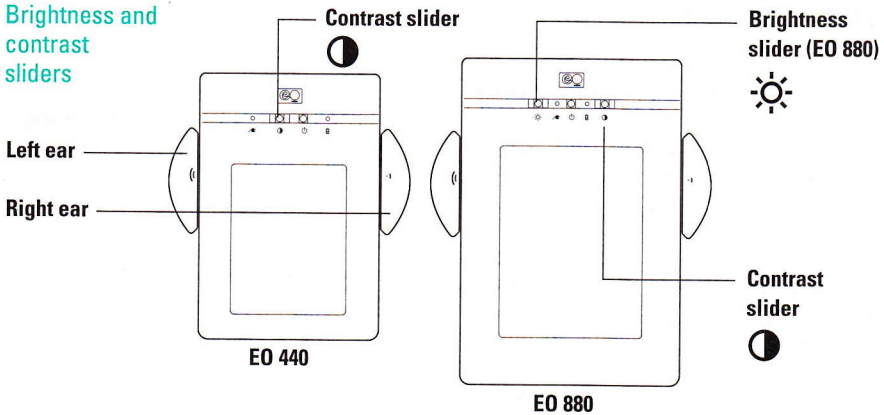

3. Place the EO on a level surface or hold it in your hands as if you were holding a clipboard.

The “ears” of the EO allow a comfortable wrap-around grip when no cables are connected to the ports that are contained in the ears (wrist behind the unit, one hand on an ear). Holding the EO by an ear allows you to keep the unit steady without obscuring the screen.

***Automatic Standby** The EO is preset to switch to Standby after 5 minutes without activity. Press the On/Standby button to switch it back on. If you wish to make the interval longer, refer to “Changing Settings,” in section 2 of the Lookup Guide. The screen of the EO 880 dims automatically after 2 minutes. Bring the pen near the screen to wake it up.*

Troubleshooting

If your EO didn't come on properly, or if you don't see the Notebook even after adjusting the screen contrast, try repeating the startup procedure. Remove both the main battery and the two backup batteries and return to "Connecting the Power Adapter," on page 2.

Taking Out the Pen

With the Notebook on the screen, you're almost ready to begin work with your EO.

- 1. Gently pull the end of the pen slightly outward, pulling toward the bottom end of the screen.**

Removing the pen

Pull the pen outward...

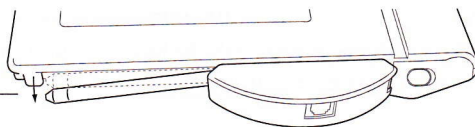

...and down.

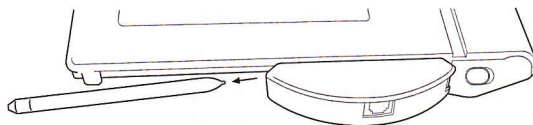

You use the electronic pen to write in the Notebook, choose commands from menus, and do other work. (You must use the electronic pen; an ordinary pen won't work.) The pen is an electronic device, but only the point is active, so you can rest your hand on the screen while holding the pen. When you put the pen away, always put the tip in first (toward the top of the EO).

You're now ready to begin session 2—an on-screen introduction to the basic skills you need for fast, accurate personal communications.

Introducing the Notebook

This session introduces you to the Notebook and shows you how to open the on-screen EO tutorial. In the tutorial, you'll actively use the pen as you learn about EO concepts and activities.

This session also shows you how to open the built-in help system.

Notebook Basics

Before you begin the on-screen tutorial, take a moment to review the way information is arranged in your EO.

The EO organizes information in an electronic Notebook that's similar to a loose-leaf notebook. The Table of Contents is the first page of the Notebook. From here, you can turn to any page in the Notebook.

The pages listed in the Table of Contents represent documents—files you create to hold letters, lists, addresses, and other information. Each document occupies a different page in the Notebook. For easy access to similar information, pages can be organized into sections. The tabs on the right side turn to the pages or sections labeled on the tabs.

Table of Contents

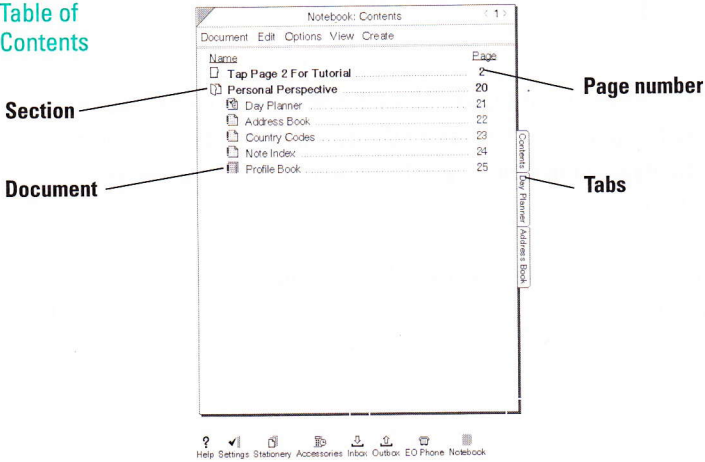

Some documents have been created for you and are ready to receive information. For example, the Address Book Page in the Personal Perspective section will hold the names, addresses, and phone numbers you add.

At the bottom of the screen, beneath the Notebook, is a Bookshelf that holds auxiliary notebooks and accessories. Each notebook or accessory is represented by an icon (a small picture). You'll use some of the items on the Bookshelf later in this guide.

Bookshelf



Starting the Tutorial

Now that you're familiar with the Table of Contents, you're ready to begin the tutorial and try out the electronic pen. The rest of this guide assumes that you have worked through the tutorial.

***About gestures** This tutorial introduces you to gestures—the marks you make with the pen to do work on the EO. In this and other EO guides, gestures are shown with a special font. For example, an instruction to tap with the pen is shown as “tap ♣.”*

- 1. If the EO is not on, switch it on by pressing the On/Standby button.**
If you've not yet set up your EO, refer to section 1.
- 2. In the Table of Contents, look for the page titled “Tap Page 2 for Tutorial.”**
- 3. Hold the pen the same way you hold an ordinary pen or pencil when you're ready to write.**
- 4. Tap ♣ the page number, 2.**
Tapping is like dotting an “i.” Lightly touch the tip of the pen to the number, and then lift the pen away from the screen.

Where to start

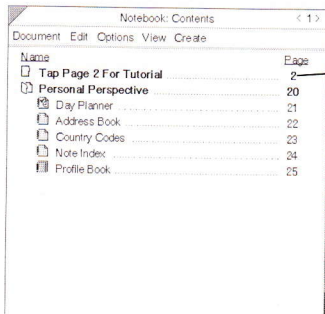

Name	Page
Tap Page 2 For Tutorial	2
Personal Perspective	20
Day Planner	21
Address Book	22
Country Codes	23
Note Index	24
Profile Book	25

Tap here.

In a moment you see a list of the tutorial section's contents.

If nothing happens You may have tapped too lightly. If you see a starburst on the screen, the pen may have slipped. Try again, tapping directly on the page number.

Welcome

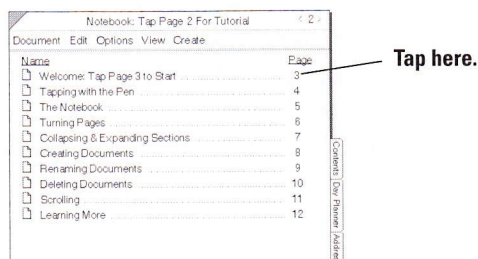

5. Tap page 3.

When you tap the page number, the EO turns to the first session of the tutorial.

6. Follow the on-screen instructions to work through the tutorial.

Your changes won't be permanent, so you can experiment as much as you like.

Troubleshooting If you find you have trouble turning pages in the tutorial, try the page-turn gesture: A short flick to the left in the title line (at the top of the page).

Finishing the EO Tutorial

When you've finished the EO tutorial, you'll need to turn back to the Table of Contents.

1. **Look on the right side of the tutorial page for a tab that says "Contents."**
2. **Tap  the Contents tab to turn to the Notebook Table of Contents.**

Getting On-Screen Help

Your EO Personal Communicator was designed to travel with you, so a help system is built in. You can leave the EO books on a shelf and still answer questions that occur to you when you're on the road. The help system is also an excellent way to learn to use the EO efficiently.

On-screen help comes in two varieties:

- **Quick Help** Provides short descriptions, how-to instructions, and explanations for objects you tap while Quick Help is open. You can learn a lot about the EO by exploring these bite-sized descriptions.
- **Help Notebook** Provides more extensive how-to instructions and explanations.

Turning to Help

Try turning to on-screen help now, pursuing any topic of special interest to you.

1. Draw a question mark ? over an object such as an icon, or tap the Help icon on the Bookshelf.

Getting help

Help icon



The PenPoint Help window opens.

2. Tap anything on the EO screen that you'd like to learn more about.

A description of the item opens immediately in the Quick Help window.

3. When you're ready to explore the Help Notebook, tap the Help Notebook button in the PenPoint Help window.

The Help Notebook opens to its table of contents.

Help Notebook

Help: Contents	
Name	Page
<input type="checkbox"/> Using Help	2
<input checked="" type="checkbox"/> PenPoint Help	5
<input type="checkbox"/> Drawing 11 Basic Gestures	6
<input type="checkbox"/> Using Contents Pages	19
<input type="checkbox"/> Using Notebooks	28
<input type="checkbox"/> Using Menus & Icons	39
<input type="checkbox"/> Using Option Sheets	47
<input type="checkbox"/> Viewing Documents	52
<input type="checkbox"/> Creating And Using Documents	58
<input type="checkbox"/> Filing Documents On Disk	65
<input type="checkbox"/> Embedding Documents	74
<input type="checkbox"/> Writing In The Notebook	81
<input type="checkbox"/> Editing And Formatting Text	89
<input type="checkbox"/> Spelling, Finding, & Replacing	101
<input type="checkbox"/> Installing Software	107
<input type="checkbox"/> Printing	110
<input checked="" type="checkbox"/> Gestures	117
<input type="checkbox"/> Applications	118
<input type="checkbox"/> EO Hardware Help	142
<input type="checkbox"/> Index	172

Help Settings Stationery Accessories Inbox Outbox EO Phone Notebook

4. Tap  the page number for any topic you want to review.

The Help Notebook works the same as the main Notebook. You tap page numbers or tabs to turn to the topic you want to review. Tap  Index for an alphabetical listing.

***EO Hardware Help** Near the bottom of the Help Notebook table of contents you'll see "EO Hardware Help." Turn to this section of help for quick answers to hardware-related questions.*

5. To return to the Help Notebook's main table of contents, tap  the Contents tab.

Closing Help

When you've finished exploring the Help Notebook, close it so that you're ready for the next session. To do so:

Tap  the close corner.

Closing help

Close corner

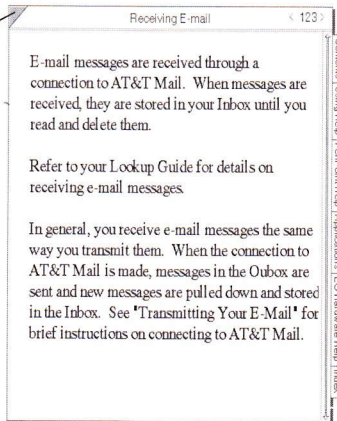

Good time for a break



Standby *If you take a break, press the On/Standby button to switch the EO to Standby. With the power adapter connected, the main battery will begin recharging while you're away. Actually, because the EO drops into Standby automatically, you'll find it in Standby if you leave it for more than 5 minutes.*

Handwriting Practice

In this session, you'll work through another on-screen tutorial. This one will show how to write with the pen so that the EO can read your handwriting accurately.

This session gives you an on-screen demonstration of the best way to write each letter and number and a chance to practice different letters, numbers, and characters so that they're easier for your EO to recognize.

For trouble-free work with applications and documents, *this session is very important.*

Aligning the Pen

Before you start the handwriting session, take a few moments to align the electronic pen. Aligning the pen shows the EO your personal writing style—the angle at which you hold the pen when you write on paper or on the screen. Proper pen alignment helps you write more recognizable letters. You need to set pen alignment only once.

1. Tap **!** the Settings icon on the Bookshelf.

Opening the
Settings
Notebook

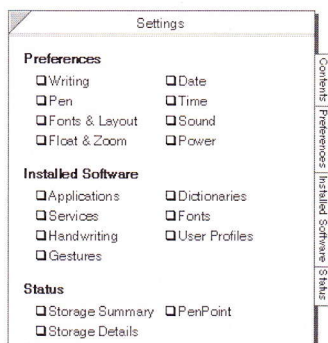

When you tap the Settings icon, the Settings notebook opens at its table of contents.

Settings
notebook

Opening notebooks and applications From now on in this and other EO guides, the action of opening a notebook, application, or service is described simply as “open.” Thus step 1 would read, “Open the Settings notebook.”

2. Tap **Pen**, under Preferences.

You see the Pen option sheet. An option sheet gives you a way of specifying certain preferences to the EO. In this case, you’ll tell the EO how you hold the pen.

Aligning the pen

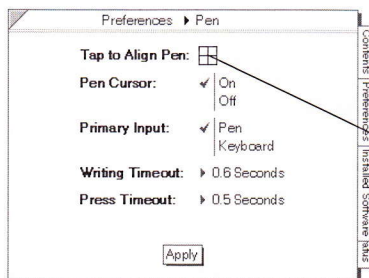

Touch where the two lines meet.

3. Holding the pen as you usually do when you write, touch the pen to the center of the crossed lines shown above.

The box should turn dark briefly. Try again if you missed the center point.

4. Tap  Apply.

This tells the EO to adopt the pen alignment you just set. From now on, the EO recognizes your angle of writing and can translate your writing more efficiently.

5. Tap  the Settings notebook's Contents tab to return to the table of contents.

In the next series of steps you'll open the on-screen handwriting tutorial, and you need to be at the Settings contents page to do so.

Opening Handwriting Practice

Now that you've aligned the pen, you're ready to practice writing a few letters and other characters. In this part of the session, you'll get an on-screen demonstration of the best way to form letters and numbers.

1. On the Settings contents page, tap  Handwriting, under Installed Software.

You see the Handwriting page.

2. Tap  Practice to begin the Handwriting session.

Handwriting
practice

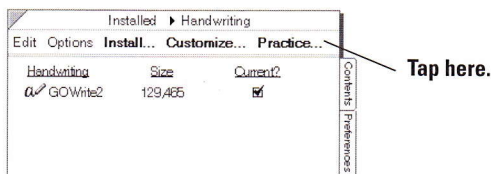



3. Follow the instructions on the screen to practice writing letters, numbers, and symbols.

You don't need to practice all the letters. Just writing a few will give you a good idea of the need for writing each character in a consistent way.

Return later You can return to this session at any time to review the best way to write a letter for recognition by the EO.

Finishing Handwriting Practice

When you've had enough practice, close the Handwriting Practice tutorial so that you're ready for the next session in this guide.

1. **Tap  the close corner of the Handwriting sheet.**
You return to the Handwriting page.
2. **Tap  the close corner of the Handwriting page.**
The Settings notebook is automatically closed.

Good time for a break



Gesture Practice

In this session you'll work through the final on-screen tutorial. This one will help you become familiar with the most-used gestures in the EO Notebook environment. You'll learn what all the gestures are, what they do, and how to draw them.

Starting Gesture Practice

You already have some experience with gestures. In the EO tutorial, you tapped ∇ to turn pages and open documents, and you drew a caret \wedge to create a new document. Now is a good time to explore the many other gestures you'll use as you work with the EO.

1. If you switched the EO to Standby at the end of the last session, switch it on (press the On/Standby button).

The Notebook appears, ready to use.

2. Open the Settings notebook.

3. Tap ∇ Gestures, under Installed Software.

You see the Gestures page.

Gesture practice

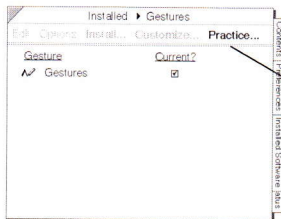

Tap here.

4. Tap ∇ Practice to begin the tutorial, and follow the on-screen instructions.

Gestures

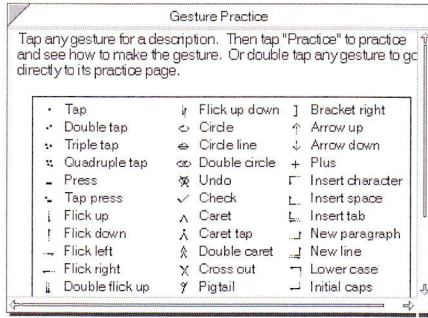

You don't need to practice all the gestures. Try a few of them, though, so that you can become familiar with this new alphabet. Here is a list of the most frequently used gestures, preceded by the symbols used for them in EO publications:



Symbol	Gesture name
X	Cross out (delete)
^	Caret (insert)
✓	Check (change options)
○	Circle (edit)
└	Insert space(s)
⌘	Undo
	Flick up (scroll page up)
	Flick down (scroll page down)
—	Flick right (scroll page right)
—	Flick left (scroll page left)
!	Tap (select)
↓	Press (move)

Symbol	Gesture name
⌘	Tap press (copy)
?	Question mark (get help)

***Come back later** You can return to Gesture Practice later on, when you need information about a specific gesture or if you forget how to draw a certain gesture.*

Finishing Gesture Practice

When you're ready to continue in this guide, close Gesture Practice so you'll be ready for the next session. Here's how:

- 1. Tap  the close corner of the Gesture Practice sheet.**
You return to the Gestures page.
- 2. Tap  the close corner of the Gestures page.**
The Settings notebook automatically closes.

Good time for a break



Setting the Day and Time

In this short session, you'll set the EO system clock and calendar and check the settings by opening the on-screen clock.

Setting Today's Date

When you create and modify documents, the EO notes the date and time based on the system clock and calendar. Also, the calendar and alarm features in Personal Perspective read the time and date from the system settings. It's a good idea to set the date and time now, since you'll be creating a new document in session 6 and working with the Personal Perspective Day Planner in session 8.

1. **Open the Settings notebook and tap \blacktriangleright Date.**
You see the Date option sheet.
2. **In the appropriate boxes, write the current date and year.**

Setting the date

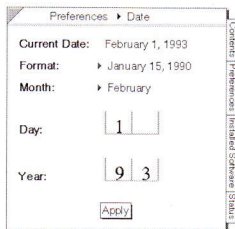

3. **Choose the options you want from the Format and Months pop-up lists.**
To choose an option, open the pop-up list and then tap \blacktriangleright the option you want. The list closes as soon as you choose an option.

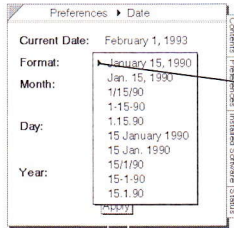
Opening a
pop-up list

Tap an arrow to
view a pop-up
list.

4. When the date is correct, tap **Apply**.
The date in the top line changes to the date you set.
5. Leave the Date option sheet open for the next steps.

Setting the Time

Setting the time involves steps similar to those for setting the date.

1. Tap **Apply** the title line in the Date option sheet to open a pop-up list.
Tapping in the title line is a shortcut.

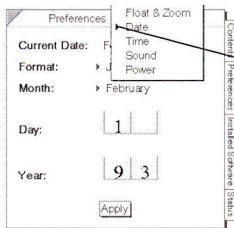
Switching
option sheets

Tap an arrow to
view a pop-up
list.

2. In the pop-up list, tap **Apply** Time.
The Time option sheet opens.

Setting the time

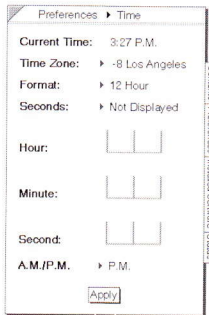

- 3. Choose the options you want from the Time Zone, Format, and Seconds pop-up lists.**
- 4. Write the current hour, minute, and second in the appropriate boxes.**
- 5. Tap \checkmark Apply.**

The time in the top line changes to the time you set.
- 6. Tap \checkmark the close corner.**

The Settings notebook closes.

Your EO system calendar and clock are now current. You can check the time by opening the EO clock, as described in the next steps.

Opening the Clock

The clock is an accessory that you can leave open on the screen as you work. You can move the clock to any convenient spot on the screen.

1. **Open Accessories and tap \checkmark the Clock icon.**

The clock opens.

The EO clock

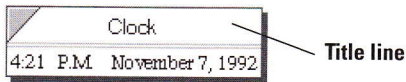



2. **Press \downarrow the title line and drag to move the clock wherever you want it.**

To change the way the clock looks, draw a check \checkmark gesture anywhere on the clock and change the settings.

3. **To close the clock, tap \checkmark its close corner.**



Faxing a Note

You're now about halfway through this guide. In this session, you'll use what you've learned so far to create a new document, write a note, and fax the note to a local fax number.

If your EO is a 4MB system, or if you don't have a modem With a 4-megabyte system, fax and e-mail applications are not available for use. If you don't have a modem in your EO, you won't be able to communicate over a phone line. To check, tap  the Document menu and then tap  Send. The Send command is dimmed if you have no modem.

Creating a Note

Suppose you're in a hotel room and need to let the home office know of a change in your travel plans. A short note written in electronic ink, and then faxed to the office, will do the job quickly. The first step is to use the MiniNote application to create a new document.

- 1. If necessary, tap  the Contents tab on the main Notebook to return to the main Table of Contents.**
- 2. Double tap  the Personal Perspective section title (not the icon) to close the section.**
- 3. Draw a caret  gesture anywhere in the blank space at the bottom of the notebook.**

The Create menu opens, showing a list of applications.

Creating a new document

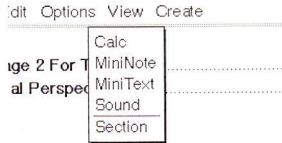
4. Tap  MiniNote.

In a moment a new MiniNote document icon appears at the bottom of the main Notebook's Table of Contents.

New document

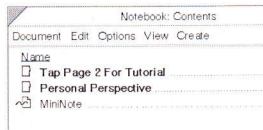

The new document is automatically named for the application that created it: MiniNote.

Renaming the Note

You rename a document—in this case the note—by writing a new name over the old one.

1. Draw a circle  gesture over the name MiniNote (in the Table of Contents).

An editing pad opens.

2. Tap  Clear to clear the editing pad.

3. Print a new name:

Trip Change

Editing pad

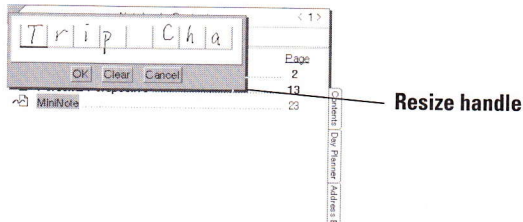

You notice immediately that the editing pad is too small for the new title.

- 4. Drag the resize handle down and toward the right to make the pad larger, and continue printing.**
- 5. Tap \checkmark OK.**
The EO translates your printing.
- 6. If you made a mistake, write the correct letter over (on top of) the incorrect letter.**
- 7. Tap \checkmark OK again to close the pad.**
The document name changes.
- 8. In the Table of Contents, tap \checkmark the Trip Change document icon to turn to that page.**
A blank note opens, with "Trip Change" in the title line.

Notice the gesture margin on the left. You make gestures in this area to select lines you've written.

New MiniNote
document

Gesture margin

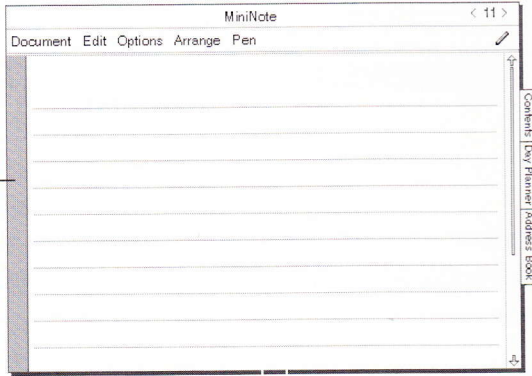

Writing the Note

1. Start writing anywhere in the note.

For this practice note, you might write something like the following:

Flight arrives Friday, not Thursday. Please cancel the Thursday sales meeting.

Thanks,

John

Practice note



2. Double tap **!** the word "meeting" to select it.

Selecting the word highlights it (a dark area surrounds the word).

One word
selected

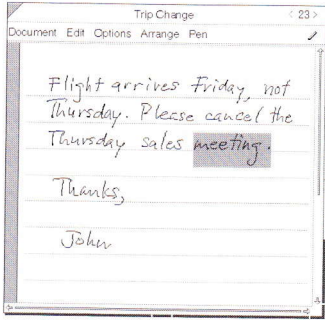

3. Draw a cross-out χ over "meeting" to delete the word, then replace it with *lunch*.

After changing
the word



If you have trouble drawing the χ , try starting both strokes from the top.

Correcting Other Mistakes

In an ink-based document like this, the EO can't tell a scribble from a gesture, so you use a special column—the gesture margin—to select lines you want to erase and rewrite.

MiniNote does not have an “eraser.” You need to select items and then delete them to make corrections.

- 1. Tap Ψ in the gesture margin to select a line.**

A gray box appears around the line.

- 2. Choose Clear from the Edit menu.**

The line is erased. You could also draw a cross out \times in the gesture margin next to the line.

- 3. Rewrite the line.**

There are many other editing methods you can use in a MiniNote document. For information, refer to the *Lookup Guide to the EO Personal Communicator* when you've finished this guide.

- 4. When you've completed the note, leave it on the screen and proceed to the next topic.**

Preparing the Note for Faxing

You're now ready to fax the note. Before you actually transmit a fax you prepare a cover sheet, just as you would for a phone-based fax device.

Since this is a practice session, you can fax the note from your EO to a fax device at your home or office. If you don't have a fax to use for practice, you can work through the addressing steps but not transmit the fax.

1. Tap **!** the Document menu, tap **!** Send, and then tap **!** GO Fax.

Document menu

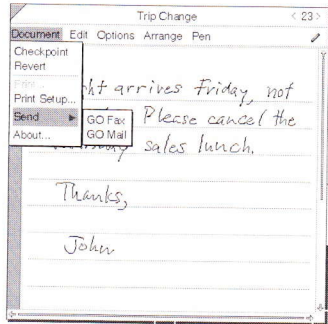

You see the GO Fax Cover Sheet, which identifies the fax to the person who receives it. The Cover Sheet is the first page of the fax.

Fax Cover Sheet

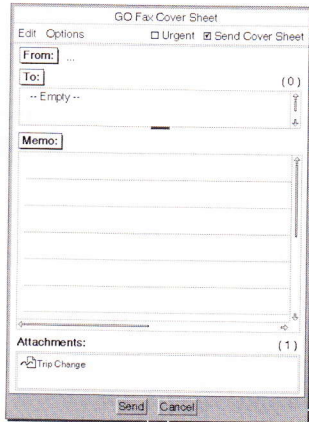

2. In the cover sheet, tap **!** From to open the From sheet.

From sheet

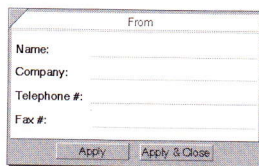

3. Neatly print your name and company, phone number, and fax number on the sheet.

The EO translates your printing as you go. You may need to make a few corrections. If so, draw a small circle \circ gesture on the name or number to open an editing pad and make your corrections in the pad.

This is a one-time step The From sheet keeps your name and number until you change it, so—unless your fax number or other information changes—you need to fill in the sheet only once.

4. Tap \checkmark Apply & Close.

Your name appears next to the From button.

Adding the Recipient's Fax Number

The next step is to add the phone number for the recipient's fax device. If you're using an office or home fax number for practice, use that number here.

1. On the cover sheet, tap \checkmark To.

You see the To sheet.

To sheet

2. **Print your name and the fax number (or any name and number to which you want to send the practice note).**

Be sure to include the area code, even if this is a local call. If you make a mistake, draw a circle \circ gesture over the name or number and make corrections in the editing pad.

3. **When the name and number are correct, tap \checkmark the Add Recipient button.**

The name and number are added to the cover sheet.

4. **Tap \checkmark the close corner.**

The To sheet closes.

5. **Tap \checkmark Send.**

The EO sends the note to the Outbox. The Outbox collects faxes (and e-mail messages) until you find a convenient moment to connect to a phone line and transmit them. If you have an EO Cellular Module attached, you can transmit at any time.

Transmitting the Fax

You're now ready to transmit the fax from the Outbox to the fax number. To transmit the fax, you first tell the Outbox that you're ready to transmit and then set up a Dialing Location sheet.

1. **Tap \checkmark the Outbox icon to open the Outbox notebook.**

You see the Trip Change note in the GO Fax list.

Outbox

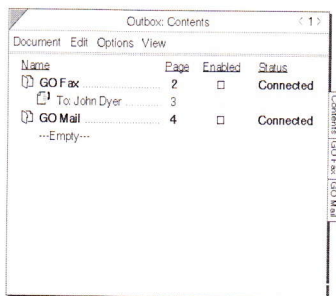

Cellular Module If you have attached an EO Cellular Module and want to transmit the fax via cellular, tap **!** the GO Fax tab. Choose Fax Service from the Options menu to open an option sheet. Change the Modem Service setting to Wireless and tap **!** Apply & Close. You can leave the GO Fax page open for the rest of these steps.

2. On the GO Fax line, tap **! Enabled to add a check mark.**

When you tap Enabled, you're giving the EO "permission" to transmit faxes.

The Dialing Location sheet opens. This sheet tells the EO where you are so that phone numbers can be dialed correctly. You can add a phone credit card number if you wish.

You need to complete this sheet only once, unless you change locations. For example, when you visit another city, you need to update the area code. If the information remains current, you simply tap **!** Continue when you see this sheet.

Dialing
location sheet

Dialing Location

Fill in the information below. This tells PenPoint how to dial phone numbers from your current location.

Where are you now? ▶ USA or Canada

Area Code: _____

Need an outside line? ▶ No

Using a Calling Card? ▶ No

What access numbers do you need to dial?

Long Distance: 1 _____

International: 011 _____

What type of phone line are you using?

Dial Type: ▶ Tone

3. Fill in your area code and other information on the Dialing Location sheet.

In most cases, you need to change only the area code.

The EO translates as you go. If you need to make a correction, draw a circle \circ gesture over a word or number to open an editing pad and make your corrections there.

4. When the sheet is complete, tap \checkmark Continue.

The Dialing Preview sheet appears, showing the dialing sequence. If you made a mistake in the fax number, you can correct it here.

5. In the Dialing Preview sheet, tap \checkmark Continue.

The EO dials the internal modem, connects, and transmits the fax. A series of messages shows the status of the transmission.

6. When transmission is complete, tap \checkmark the Enabled box on the GO Fax line to disable fax transmission.

7. Tap \checkmark the close corner of the Outbox.

The next time you send a fax—if you haven't changed locations—you simply fill in the cover sheet, send the fax to the Outbox, open the Outbox, and tap Enabled. All the fax setup time is behind you. If you create several faxes during the day, you can let them collect in the Outbox and send them all at once when you're ready.

More About MiniNote and GO Fax

For complete information about working with MiniNote documents, refer to section 10 of the *Lookup Guide to the EO Personal Communicator* after you've finished this guide. For information about GO Fax, refer to section 6.

Refer also to *The World of Messaging: An Introduction to Personal Communications* for information on addressing and other general concepts related to electronic messaging.

Good time for a break



Writing a Letter

When you wrote a note in session 6 you wrote in ink, in a MiniNote document. This session introduces you to a different kind of writing: writing for text translation.

In this session you'll learn to use MiniText—a basic word-processing application that comes with the EO—to write and revise a short letter.

About Text

In a MiniText document, you write words and sentences and then have the EO translate your writing into computer text. Translated into text, your writing is easier for others to read. Also, you can style and format text as if it were typeset. Ink, on the other hand, is like paint. What you see is what you get—legible or not.





There's another advantage, too: text can be smart. What you learn in this session about text translation will be very important in session 8, "Organizing Your Day." In Personal Perspective, text is not simply easier to read—it's intelligent.

***Electronic mail** When you want to send an electronic mail message to someone who doesn't have an EO, you must use translated text.*

Creating a New MiniText Document

Suppose you want to write a short report about a client meeting. The report will become part of the client file, so you want it to look neat and professional. A MiniText document works well for these purposes.

When you create a MiniText document for this session, you'll be using the same procedure you use to create other EO documents. These include MiniNote, EO Sound™, and EO Calc™ documents (covered in the *Lookup Guide*).

1. If necessary, tap  the Contents tab on the main Notebook to turn to the main Table of Contents.
2. If you reopened the Personal Perspective section, double tap  the section title to close it.
3. Draw a caret  gesture at the bottom of the Table of Contents. You can also tap  Create on the menu bar.

The Create menu opens, showing a list of document types, including MiniText.

4. Tap  MiniText.

In a moment a new document icon appears at the bottom of the main Notebook's Table of Contents. The new document is automatically named for the application that created it: MiniText.

Creating a new document

MiniText
document icon

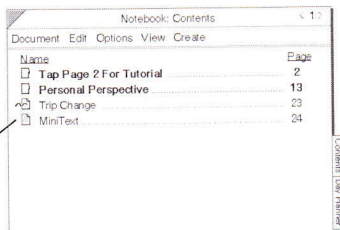

Name	Page
Tap Page 2 For Tutorial	2
Personal Perspective	13
Trip Change	23
MiniText	34

5. Rename the document, giving it the title

Report

As before, simply draw a circle \bigcirc gesture on the name.

6. Tap \forall the Report icon to turn to that page.

MiniText menus appear at the top of the document, above a boxed writing pad. The letter boxes used in the pad help you print distinctly and consistently.

A menu is a list of commands you use to tell the EO what you want to do. Most commands can be activated by using gestures, but until you've learned the most often-used gestures, you can do most of your work by using menus.

MiniText
writing pad

MiniText
menus

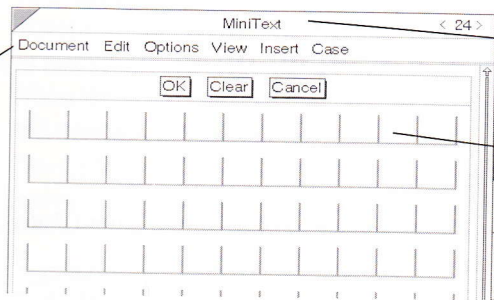

Title line
(yours will
say "Report")

Letter
boxes

Writing in the pad

1. Using uppercase (capital) and lowercase letters, print a few words:

*The meeting with Amy Arnett was scheduled
for Thursday.*

Print naturally, as you would if you were printing for a person you've never met. Use the same pen movements as when you print a note on a sheet of paper. Don't try to make corrections at this point, but simply write some words.

When you get to the end of the line, don't skip a box, but continue in the first box on the second line.

If there isn't enough room to fit the words on the pad, you can resize the writing pad. To do so, drag the resize handle downward (as if you were pulling down a window shade).

Printing a few words

Word "Arnett" continues here.

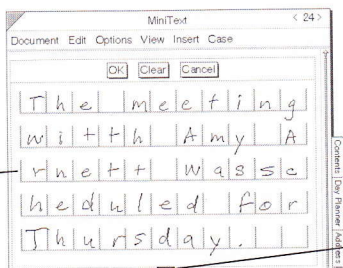

Resize handle

2. Tap **OK**.

The EO translates your writing into text and leaves the pad open. You may notice some mistakes.

3. To make corrections:

- To correct a letter, print over the letter (that is, on top of the letter).
- To insert a space before a letter, draw an insert space  gesture over (on top of) the letter. Begin the gesture in the center of the letter box and draw the horizontal line below the letter-box line. Make the tail of the gesture extend beneath the next box. Drawing a longer line adds more spaces.

Inserting a space

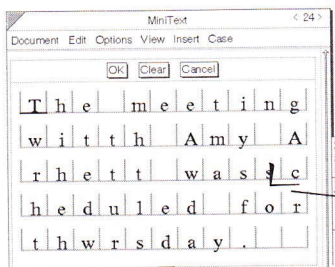

Insert space (down right) gesture

- To delete (erase) a letter, draw a flick up gesture over (on top of) the letter. Begin the flick in the center of the letter box and end it above the top of the box. Make the top of the gesture extend into the box above.

Deleting a letter

Flick up gesture

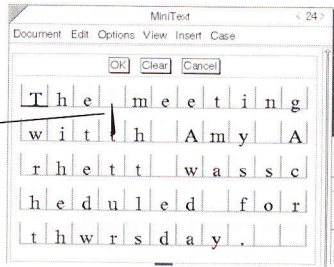

- If you see a question mark in a dark circle, it means that the EO didn't understand the letter you printed. Reprint the letter over (on top of) the question mark.

4. When the words are the way you want them, again tap **OK**, and notice what happens.

The writing pad stays open, and the words you printed are inserted, in text form, at the top of the MiniText document.

Text in the document

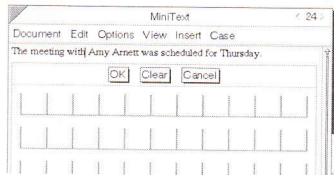

If you find the words difficult to read, you can make the text appear larger by choosing Magnify Text under the View menu.

Adding More Text

1. **Now skip a line of boxes and print a few more words:**

Amy will sign the new contract next week.

Skipping a line of boxes tells MiniText that you want to begin a new paragraph. If you run out of space in the pad, translate and insert the first words, drag the resize handle to make the pad longer, and continue printing.

2. **Tap ! OK to translate and insert the words**

3. **Make any needed corrections and again tap OK.**

The words appear in the document after the words you printed earlier.

Inserting a Word in the Middle

1. **In the actual document (not in the writing pad), draw a caret \wedge between the words "contract" and "next."**

An editing pad opens.

2. **Print:**

early

3. **Tap ! OK to translate the word.**

4. **Make any needed corrections and again tap ! OK.**

The word appears in the document after the point at which you drew the caret \wedge for an insertion. The last sentence should now read

Amy will sign the new contract early next week.

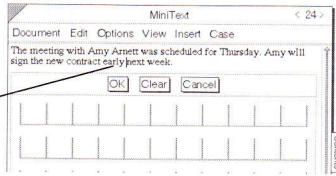

After
insertion

Inserted word



Returning to the Table of Contents

You can continue to write and translate text if you need more practice. When you're ready, return to the Table of Contents so that you're ready for the next session.

- 1. Tap  the Contents tab for the main Notebook.**
You never really close a document on the EO. Instead, you simply turn to another page. When you do, the EO automatically saves the contents of the document.
- 2. To verify this, tap  the Report icon in the Table of Contents.**
The Report document reopens, with your text intact.
- 3. Tap  the Contents tab now so that you're ready for the next session.**

More About MiniText

You can change the appearance of text by changing the type font, size, and style. You can also indent paragraphs, add tabs, and otherwise polish the look of a MiniText document. For complete information on using MiniText documents, refer to section 10 of the *Lookup Guide to the EO Personal Communicator* after you've finished this guide.

Organizing Your Day

Now that you've written some text for translation, you're ready to get started with Personal Perspective, an intelligent information manager that looks much like a paper planning book.

In this session you'll learn to use the Day Planner for scheduling appointments, add a name to the Address Book, and work with linked information.

Turning to the Day Planner

Personal Perspective gives you everything you need to keep track of daily appointments and events, to-do items, and addresses. In the EO Notebook's Table of Contents, you see four Personal Perspective documents. The Day Planner and Address Book are two of these. Because you'll probably be using the Day Planner and Address Book often, both have been assigned tabs for quick access.

Tap  the Day Planner tab on the main Notebook.

You see a calendar page that's similar to a page in many schedule planners.

Day Planner

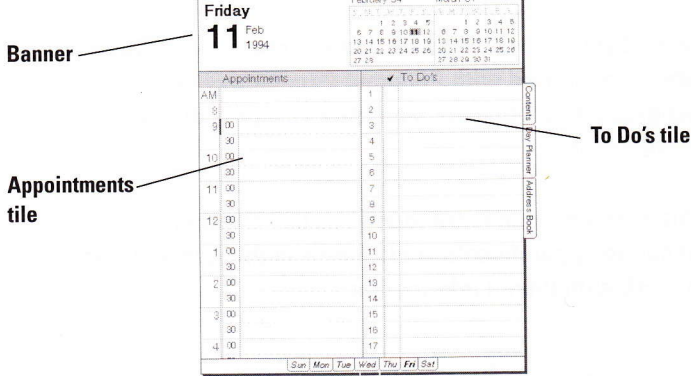

The page is divided into tiles—Appointments on the left, To Do's on the right. You can rearrange these later if you need more space in one of the tiles.

Switching to Text

In Personal Perspective, you can write in ink or translate your writing into text. Translating your writing into text allows Personal Perspective to link related information as you add it.

The icon at the top of Personal Perspective documents determines whether the application sees your writing as ink or as text to be translated.

Switching between text and ink

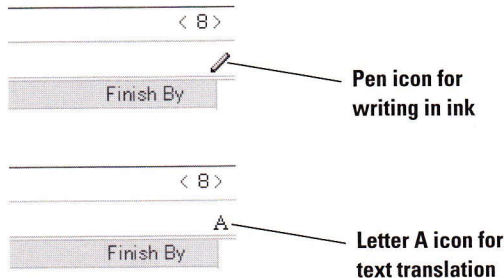

In this session, you'll write for text translation so that you can see how Personal Perspective automatically links related information.

Tap  the pen icon now to switch to the letter A icon.

Scheduling an Appointment

Suppose you're just starting the week and need to schedule several appointments over the next few days.

You first need to make sure you're on the correct page for today. If you set the system clock in session 5, and if you've not turned the page, the Day Planner should open to today's date. It always turns to the page you last viewed.

- 1. If you've turned the page away from today's date, tap  the bold date tab at the bottom of the Day Planner Page.**

Turning to today's page

The bold date tab on your page may not be Saturday.

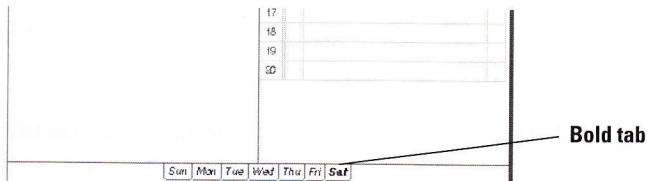

Today's date appears in the banner. The tabs at the bottom of the page give you a quick way to turn to any day of the current week.

- 2. In the 9 A.M. time slot, print**

Conference call

The EO translates as you print. To improve translation, print as neatly as you can. You may find that it helps to pause to let each word translate separately.

Setting an appointment

Appointments		✓ To Do's	
AM		1	
8		2	
9	00 Conference call	3	
	30	4	
10	00	5	
	30	6	
11	00	7	
	30	8	
12	00	9	

To make a correction, draw a circle \bigcirc over a word to open an editing pad and make your corrections in the pad.

Moving the Appointment

Now suppose the conference call is rescheduled for 11:00. You can move the appointment without rewriting it.

- Press \downarrow the time portion of the 9:00 slot (press \downarrow on top of 9:00).**
You see a single dashed line around the appointment. The dashed line—a marquee—shows that an object is ready to be moved.
- Drag the item to the 11:00 A.M. slot and then lift the pen.**
“Conference call” moves to the new slot.

Moving the Appointment to a Different Day

Suppose the conference call is moved to the next day. You can easily move the appointment without rewriting it.

- Press \downarrow the time portion of the 11:00 time slot.**
You see a marquee around the appointment.

2. In the banner calendar, tap  the date for the next day.

The next day's page opens. (You could also tap the day tab at the bottom of the page.) Notice that the "Conference call" item floats on top of the new page.

3. Drag the appointment to the 12:00 time slot and lift the pen.

"Conference call" now appears at 12:00 on that page.

Canceling an Appointment

If the conference call is canceled, you can easily delete the appointment:

Draw a cross-out  over the hour in the time slot for the appointment.

This part of the session has given only a brief introduction to the Day Planner. For more information, and to learn how to work with to-do items, refer to the *Lookup Guide* when you've finished these sessions. An introduction to another Personal Perspective document, the Address Book, is next.

Turning to the Address Book

The Address Book lists names and numbers you add for people you frequently call or to whom you send e-mail and fax messages. You can use phone numbers added here when you dial calls or address faxes.

1. Tap  the Address Book tab.

You see a page from the Address Book. You don't need to return to the Table of Contents to turn to a tabbed page.

Address Book

Banner

Your E page may look different.

Alphabetic tabs

Name	Business Phone	Fax	Home Phone
EO, Inc.	(415) 903-8100	(415) 903-0000	

2. Tap **!** the **A** tab at the bottom of the page to turn to the **A** page.

3. On a blank line under the **Name** column, print:

Amy Arnett

Pause between words. The EO translates as you print.

Name on A page

American Airlines	(800) 433-7300
Analleen Airlines	(800) 327-7230
Amy Arnett	

Text recognition If the EO doesn't recognize the A's in the name, you'll get a message telling you the name is on the wrong page. Tap **!** Edit, revise the name, and tap **!** OK.

Amy Arnett's name now appears on the A page.

Using Intelligent Text

When you added Amy Arnett's name to the Address Book, the name became part of a collection of information called the ProfileBook. Personal Perspective checks any text you write against existing information and can link together related names, companies, and notes. For example, now that Amy Arnett is listed in the ProfileBook, her name will be recognized wherever you write it.

***Profiles** If in the course of working through this session you see an on-screen request to create a profile, and you create one, you'll be adding information to the ProfileBook. A profile is an on-screen form through which you view the information collected in the ProfileBook.*



To get a feel for how information links work, try these steps.

1. Tap  the Day Planner tab.

You see the page for the most recent day you viewed. For these steps, it doesn't matter what day you're on.

2. In the 9 A.M. time slot, print

See Amy

The EO translates as you print. Draw a circle  gesture to open an editing pad, if necessary, to get "Amy" exactly right. Tap  OK to close the editing pad.

3. Notice what has happened to Amy's name.

The name appears in **bold type**. A Personal Perspective tool called the Associate uses bold type to show that an item is linked to other information.

Linked
information

Bold name

Appointments	To Do's
AM	1
8	2
9:00 See Amy	3
9:30	4
10:00	5
10:30	6
11:00 Conference call	7
11:30	8
12:00	9
12:30	10

4. To check out the link, double tap **! Amy's name.**

Amy Arnett's profile appears. As noted earlier, a profile is a way of viewing information collected in the ProfileBook.

5. Draw a flick up | gesture to scroll to the bottom of the profile.

In the Calendar Items area, you see the 9 o'clock appointment with Amy. The Associate has automatically linked the appointment with Amy's profile. Whenever you make an appointment with Amy, the Associate adds that appointment to Amy's profile.

Information in
a profile

Linked
information

Person: Amy Arnett

Profile Edit

Person

Address

City

State ZIP

Notes Documents

Calendar Items

See Amy Jun 3, 94 9:00 AM

General Links

6. Tap **! the profile's close corner to close it.**

Writing a Linked Note

Suppose you need to remind yourself of a legal question that you want to ask Amy Arnett at your scheduled meeting. You can write a note to yourself that will be automatically linked to Amy's name. Follow these steps.

1. **With the Day Planner page still open, tap  Create and choose Note from the Create menu.**

A note is similar to the MiniNote document you created in session 6.

2. **Tap  the small pen icon near the top right corner of the note so that the letter A appears.**

This tells the EO to translate your writing into text. (If the letter A is already showing, leave the setting as is.)

3. **Within the note, print this reminder:**

Amy
Legal question

The EO translates the note as you print. As soon as you print "Amy," the name is made bold to show that the Associate has recognized the name and linked it with other information about Amy.

4. **Tap  the note's close corner to save the note and close it.**

Checking the Note

To remind you that the note you wrote is linked to the appointment, the Associate puts a note icon in Amy's profile and next to her name in the Address Book. Follow these steps to check the results.

1. **Tap  the Address Book tab to turn to the Address Book.**

- 2. If you've turned away from the A page, tap  the A tab at the bottom of the page to turn to the A page (for Arnett).**

Notice the icon in the Notes column to the right of Amy's name. This icon lets you know that a note is linked to Amy's name.

The link formed in this example was automatic. You can also link information by hand, and you can link a note to an appointment.

- 3. Tap  the note icon.**

A label appears, showing the name and date of the note. If several notes had been linked to Amy's name, all would be listed in the label.

- 4. Tap  the label to reopen the note.**

The note reappears, showing the contents you wrote.

- 5. Tap  the close corner to put away the note.**

More About Personal Perspective

There is much more to learn about managing information with Personal Perspective. For complete information, refer to section 8 of the *Lookup Guide to the EO Personal Communicator* after you've finished this guide.

Recharging the Battery

You're almost to the end of this guide. During the previous sessions, you've been working with the power adapter attached to the EO. You need to leave the adapter connected for a while so that the main battery—discharged during shipping—can get a full charge.

In this session you'll switch to Standby and learn how to get a full charge into the main battery. This session also provides a quick refresher on what you've learned in this guide.

Recharging

You can continue to use the EO now, but be sure to return here to learn how to recharge the main battery. Follow these steps.

1. Switch to Standby by pressing the On/Standby button.

Switching to Standby

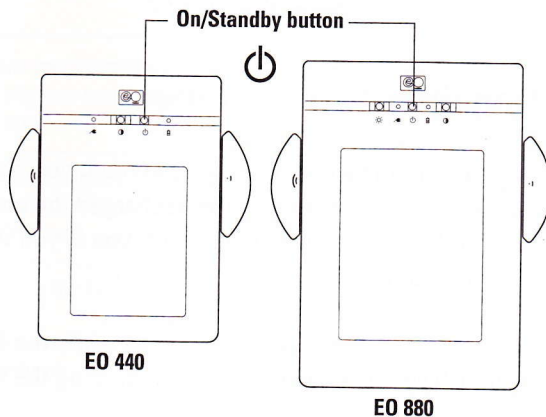

As noted in session 1, Standby is a sort of “cat-nap” state for the EO. The next time you press the On/Standby button, the Notebook will appear almost instantly.

2. Leave the power adapter plugged in for about 90 minutes, during a time when you're not using the EO.

Make sure the EO stays in Standby so that charging can take place. The green charging light flashes while the battery is recharging. The main battery does not recharge while you're using the EO, even when the adapter is connected. To recharge, the adapter must be plugged in and the EO must be in Standby state. For a more complete explanation of the lights and charging, see section 1 in the *Lookup Guide*.

3. When the charge is complete, the green light goes off.

A full charge should give your EO 2 to 4 hours of use in the On state, depending on the type of use. An optional extended life battery that allows up to 6 hours of use is available for the EO 440.

***Battery life** The first three or four times you use your new battery, it will not operate for the full capacity. Only after the battery has been used and recharged several times will it warm up to full capacity.*

Disconnecting the Adapter Cable

If you want to take your EO on the road, you should disconnect the power adapter after you've recharged the main battery. Remember to take the adapter with you if you think the battery will need a recharge.

You can leave the adapter connected while the EO is desk-bound. There is no danger of overcharging the main battery.

1. **Grasp the sleeve of the adapter plug at the point where the plug enters the EO port.**

You can unplug the adapter plug at any time, even when the EO is on.

2. **Slide the sleeve in the direction of the cable to release the plug, and then pull out the plug.**

On Your Own

Congratulations on completing the practice sessions in this guide! All that remains is for you to register your ownership and sign up for an AT&T Mail account. These topics are covered in session 10.

Remember that you can return to this book at any time to review a topic or to reopen the practice sessions.

Reminders

To do this

Do this

Create a new MiniText document (if you want to translate your writing into text and send an electronic mail message)

From the Notebook's Table of Contents, choose MiniText from the Create menu.

Create a new MiniNote document (if you want to write in ink and send a quick fax, or if you simply want to do a drawing)

From the Notebook's Table of Contents, choose MiniNote from the Create menu.

Review basic activities in the EO Notebook

Return to session 2 for instructions on opening the EO tutorial.

Learn and practice gestures

Open the Settings notebook, tap **!** Gestures, and then tap **!** Practice.

Practice writing on the screen

Open the Settings notebook, tap **!** Handwriting, and then tap **!** Practice.

Save a current document and any changes you've made to it

Turn to a different page in the Notebook, or choose Checkpoint from the Document menu.

To do this

Fax a document

Do this

Select the document title in the main Notebook, or open the document you want to send. Then choose Send > GO Fax from the Document menu and complete the cover sheet.

Get on-screen help

Write a question mark on any object on the screen, or tap  the Help icon on the Bookshelf and follow the help instructions.

Where to Go from Here

When you want to learn more advanced ways of performing certain activities—or if you run into trouble—you can turn to several other information sources provided with your EO Personal Communicator.

Lookup Guide to the EO Personal Communicator

The *Lookup Guide to the EO Personal Communicator* provides details on all important EO features. The *Lookup Guide* is designed as a random reference resource. It gives explanations and step-by-step instructions for frequently used procedures.

Where to go in the Lookup Guide

Section 6, "GO Mail and GO Fax"

Section 2, "Basics"

Section 3, "Documents"

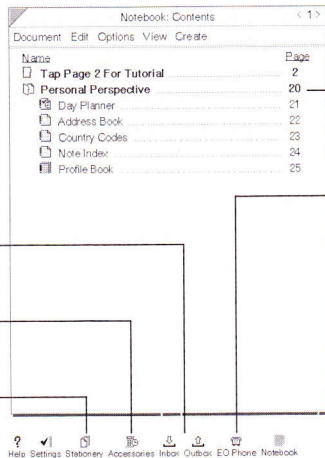

Name	Page
Tap Page 2 For Tutorial	2
Personal Perspective	20
Day Planner	21
Address Book	22
Country Codes	23
Note Index	24
Profile Book	25

Bottom menu: Help, Settings, Stationery, Accessories, Inbox, Outbox, EO Phone, Notebook

Section 8, "Personal Perspective"

Section 7, "EO Phone"

The World of Messaging

The World of Messaging: An Introduction to Personal Communications introduces you to the concepts involved in fax and e-mail messaging. This book can also help you learn how to determine another person's e-mail address and how to use electronic messaging efficiently and effectively.





Quick Help

Quick Help gives summary descriptions of objects on the screen. Quick Help travels with you and is available on-screen. Write a question mark on any object on the screen, or tap  the Help icon on the Bookshelf, to look up topics of interest.

Help Notebook

The Help Notebook provides comprehensive detail on many topics. Like Quick Help, the Help Notebook travels with you and is available on-screen. A special section, "EO Hardware Help," tells you how to manage battery changes when the *Lookup Guide* isn't handy. To open the Help Notebook, first open Quick Help by drawing a question mark anywhere on the screen. Then tap  the Help Notebook button.

Practice and Experimentation

EO encourages you to try out all the menus and open all the dialog and option sheets to see what they do. If you get mixed up, tap  the Contents tabs or close corners to return to the spot where you started. There is very little you can do to harm the software, and the best way to learn about your EO Personal Communicator is to try out all its features. The three best gestures to use are  to see what options are available,  to get help, and  to make changes.

EO Incorporated

800A East Middlefield Road
Mountain View, CA 94043

Part No. 043-0100001-41
Printed in the U.S.A.
Printed on recycled paper.